



Modelo: SSC03- __

Luminario Solar Two in One

ALUMBRADO PUBLICO



Área de aplicación



Exteriores



Áreas
Deportivas



Plazas



Parques



Carretera ó
Calle

Características

- Lámpara solar 2 & 1 para poste o muro con batería de litio
- Incluye brazo ,luminario, panel, control remoto
- Detecta movimiento y aumenta la intensidad de la luz
- Fácil instalación



Especificaciones Técnicas

Watt	60W	100W	150 W	200W
Kelvin	6500			
Lumen	4200	7000	10,500	14,000
Panel Solar	10V/20W	10V/35W	10V/40W	10V/50W
Batería	6.4V/11AH	6.4V/16.5AH	6.4V/22AH	6.4V/27.5AH
Medida Panel (A*B*C)	348*348*17mm	578*358*17mm	644*358*17mm	670*444*18mm
Medida Luminario (A*B*C)	335*150*90mm	405*178*90mm	465*214*90mm	510*232*90mm
Medida Brazo(A*B)	445*155mm	530*155mm	530*155mm	530*155mm

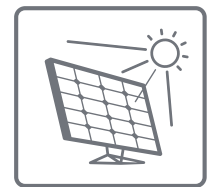

100% Solar

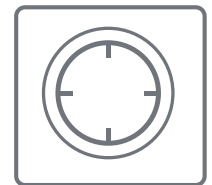

Temporizador

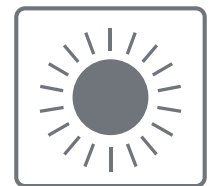

Control inteligente de luz



Control remoto inalámbrico

Dimensiones

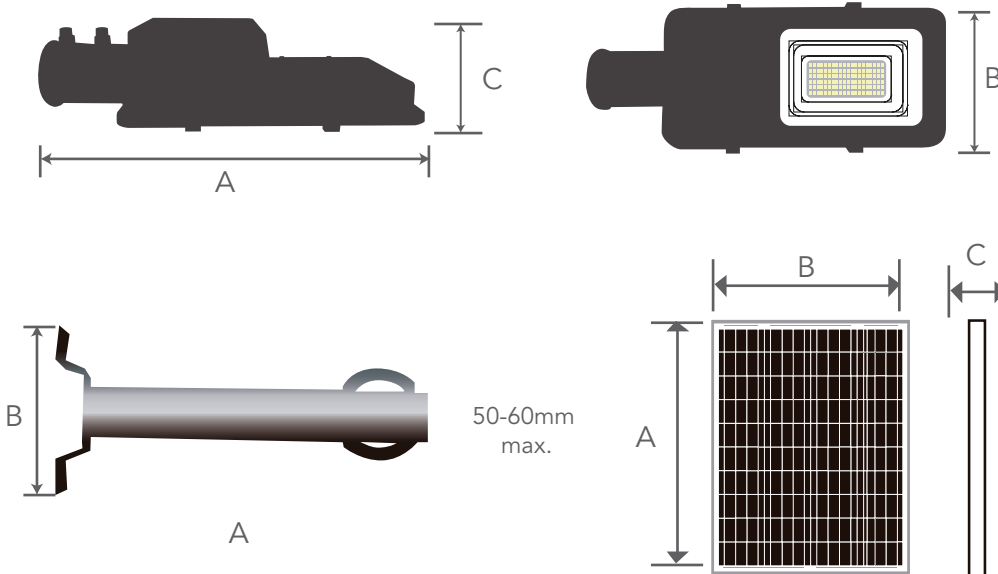

Detalles del Producto



Control Remoto
(varias funciones)

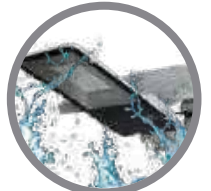

Resiste exposición
de agua

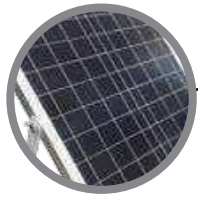

Panel de LED



Base de Metal
Ángulo Ajustable



LED chip de
Alta eficiencia

Batería Ionlitio
Interior

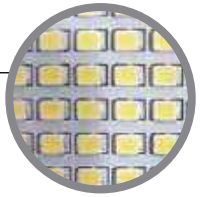

Ø60mm
Tornillos para ajuste
de brazo Max. de Brazo



Batería de ciclo profundo
Duración con clima nublado
3 Días

Métodos de Instalación



Contenido (piezas)

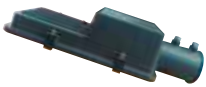

1 Luminario Solar



1 Panel Solar



1 Control Remoto
2 Pilas AAA



4 Tornillos Expansion
4 Tornillos Cuerda Corta



1 Brazo para Fijación



1 Base de Metal
Ángulo Ajustable



2 Llaves Allen

Curva de Distribución y Distancia (Lx)

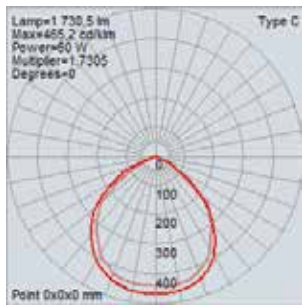
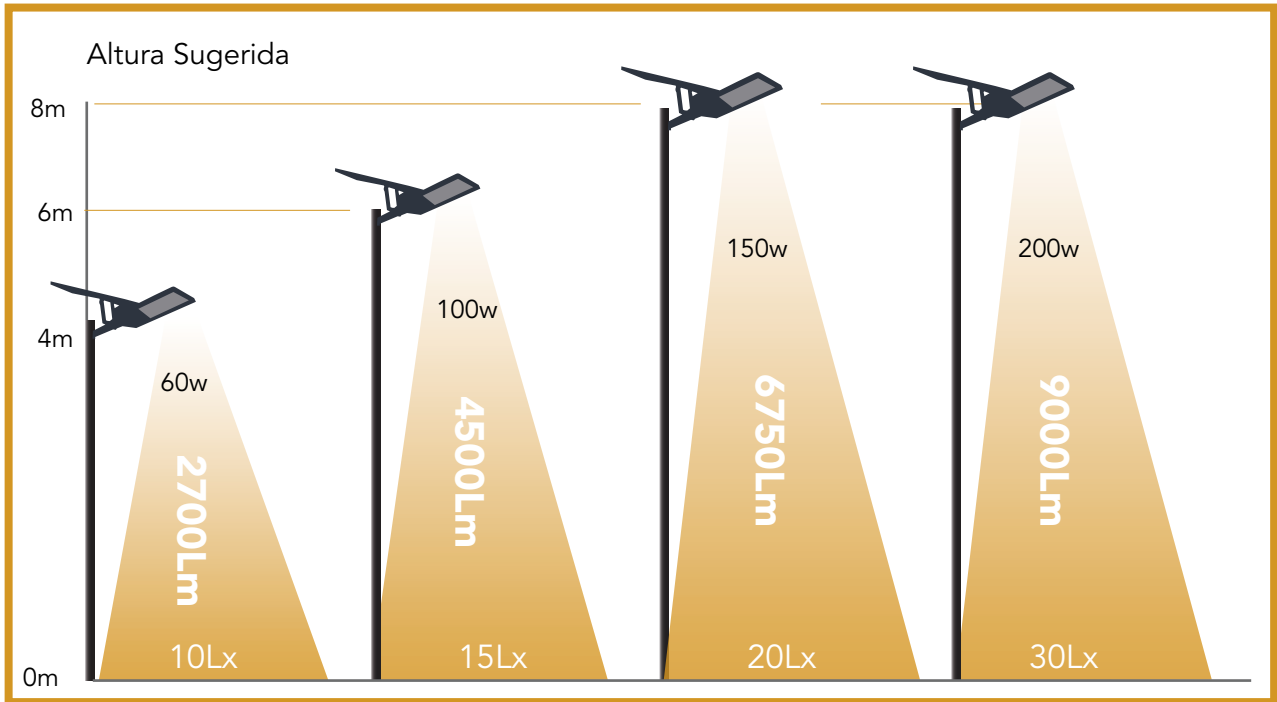

60w

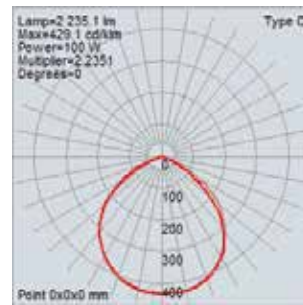

100w

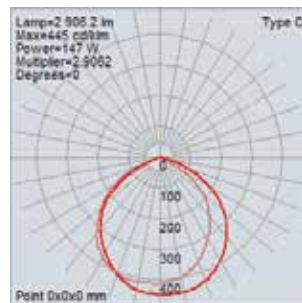

150w

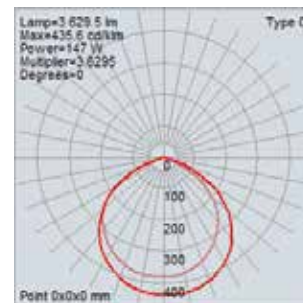

200w

Importante

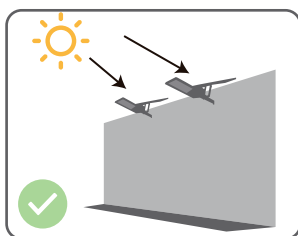

Forma correcta de instalación
Carga Completa

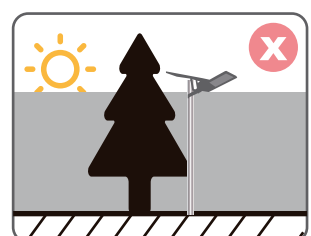
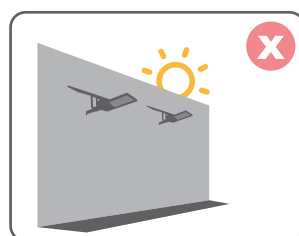
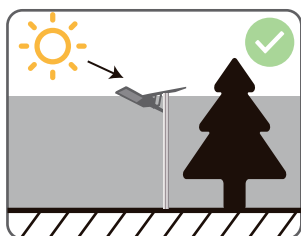

Forma incorrecta de instalación

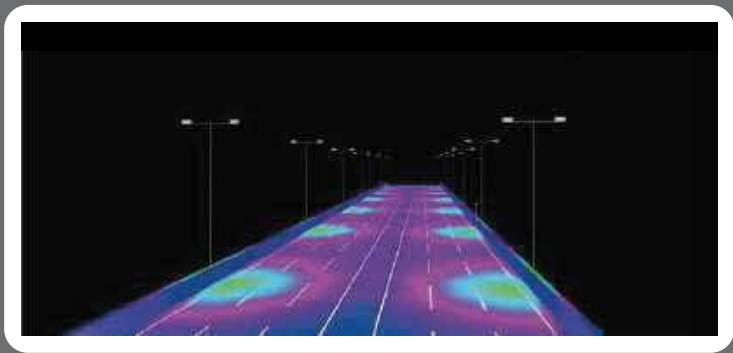

 **35 000 Hrs**
Vida Media

Notas: Imágenes Ilustrativas

Diagrama de funciones

(control remoto)



*Defectos de Fabricación



ventas@illuminer.com.mx
distribucion@illuminer.com.mx

www.illuminer.com.mx

Envíos a Todo México



(33) 1370 3874
(33) 1611 9177



(33) 3854 7846
(33) 2265 2513

© Illuminer. Soluciones en Iluminación | 2022